

部番 PART.NO.	名称 NAME OF PART	材質 MATERIAL	個数 Q'TY	備考 NOTE
----------------	--------------------	----------------	------------	------------

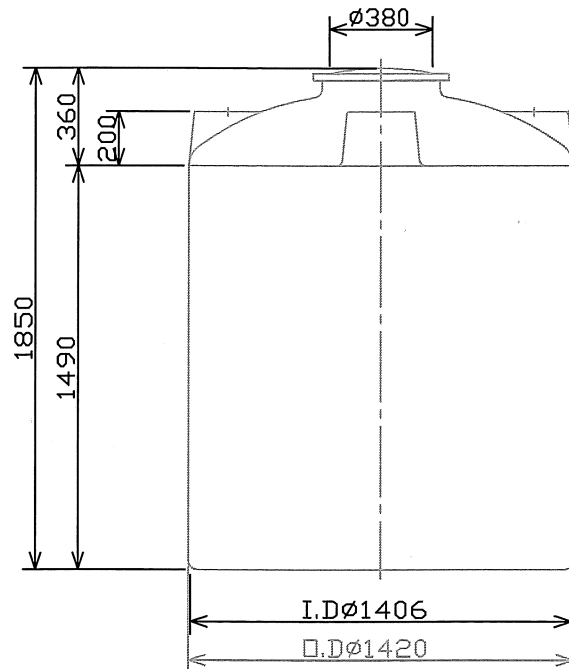
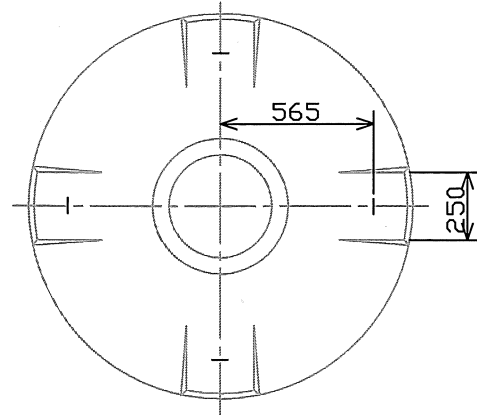

MC-2000